



oneQ is by far the easiest and most flexible built-in barbecue on the market. All modules have the same size, so you can use the same opening in your kitchen counter or garden table for several purposes.

You simply create a standard sized opening and then you can place any oneQ function in that opening: a FLAME gas grill, a GLOW charcoal grill, an ICE wine cooler, a WET sink with a faucet, a BAMBOO cutting board or even a small kamado grill. All functions are interchangeable, so can use a wine coolers one day when you are just having drinks and put in a grill the next day when you guests for a barbecue party.

Built-in OPTIONS



oneQ Roasting Hood
Optional grill hood with hinge, glass window and thermometer.



oneQ Flame
Or any other oneQ module.



Built-in Socket
Mandatory for oneQ Flame and oneQ Glow. Not necessary for any other oneQ modules. Remove foil and apply the 4 supplied silicone buffers into the Socket before use.

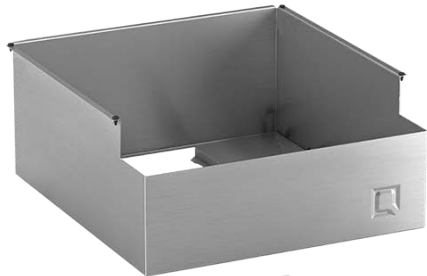

Built-in (Hood) Adaptor
Fits in any 41x41 cm square opening. Built-in Hood Adaptor always required when using a Roasting Hood. Regular Built-in Adaptor not necessary when creating a recessed groove in the opening (see measurements on next pages).

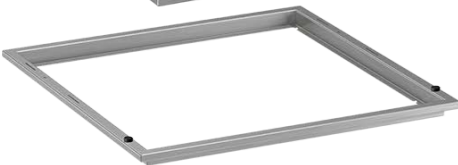

Measurements WITH ADAPTOR

WITHOUT ADAPTOR

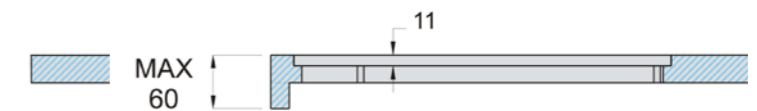
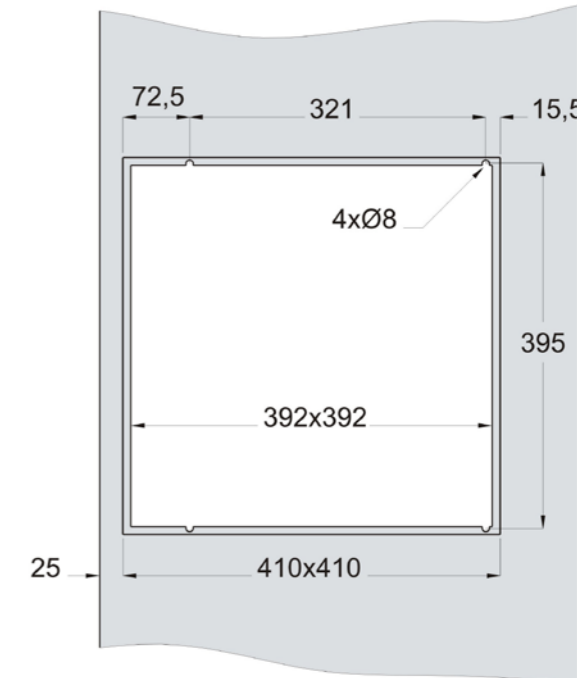
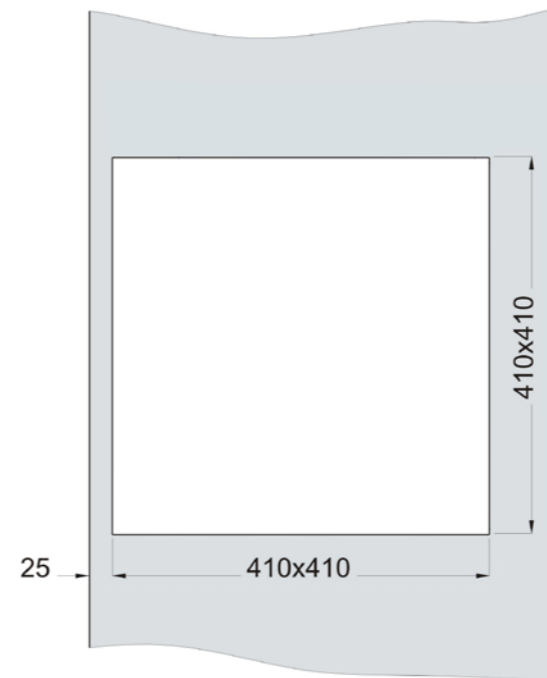
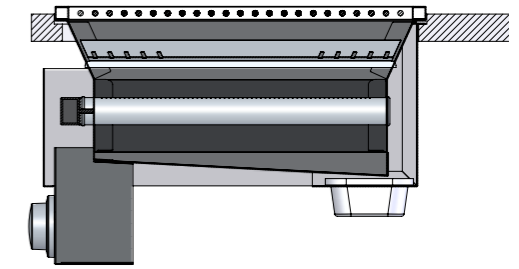
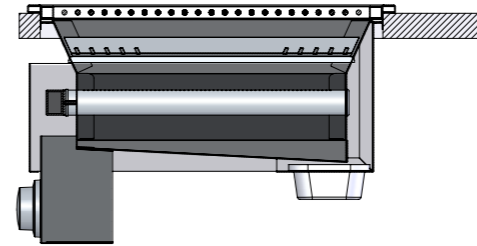

Built-in

REMARKS AND WARNINGS

- The direct installation of oneQ products into a countertop or table requires a square opening with a recessed groove.
- Please adhere to the measurements in this manual.
- The oneQ socket is mandatory for building in a Flame or Glow. Apply the 4 supplied silicone buffers to the Socket. Please remove all foil before using the Socket.
- Only build in the oneQ Flame or Glow into a non-combustible surface. oneQ is not liable for any damage or coloring of the surface the oneQ is build into.
- Ensure there is enough ventilation and air flow underneath and around the surface.
- The use of a Built-in Adaptor provides extra protection and excludes the need for a recessed groove in the opening in the kitchen surface or table.
- The Built-in Hood Adaptor is required when using a Roasting Hood and also excludes the need for a recessed groove in the opening in the kitchen surface or table.
- If you have any questions regarding safety or the procedures described in this manual, please contact us at info@one-q.com or visit one-q.com.



oneQ PRODUCTS



FLAME GAS BARBECUE
201501701



GLOW CHARCOAL BARBECUE
900901710



ICE BLACK
200901720



ICE INOX
100901720



WET BLACK
200901730



WET INOX
100901730

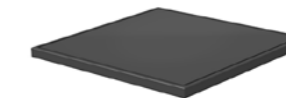

TABLE (POLYETHYLENE)
800901740



BAMBOO CUTTING BOARD
700901750



BUILT-IN SOCKET
900901750



BUILT-IN ADAPTOR
900901751



BUILT-IN HOOD ADAPTOR
900901752



ROASTING HOOD
201501920



CLOSE
900901940

For all oneQ products, prices and additional information, please contact us at info@one-q.com.