



**BROMIC**<sup>®</sup>  
HEATING



# ECLIPSE SMART-HEAT™ ELECTRIC

Reimagine the outdoors with our Eclipse Smart-Heat™ series. Available in seven unique designs, the Bromic Eclipse series adds style, warmth and light to design-focused outdoor spaces.



ECLIPSE ELECTRIC PORTABLE



600MM TWIN CEILING MOUNT POLE



600MM STRAIGHT CEILING MOUNT POLE

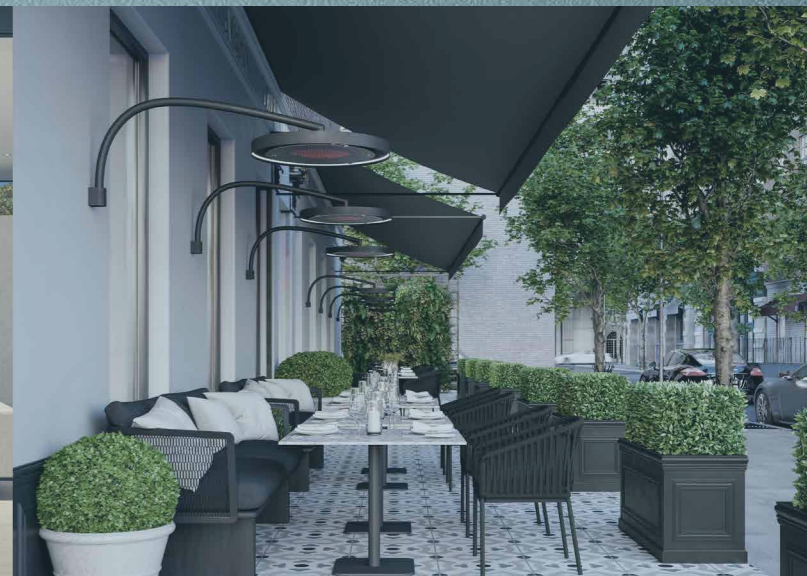

WALL MOUNT

ECLIPSE  
SMART-HEAT™ ELECTRIC  
PORTABLE

---

Add warmth and comfort to outdoor spaces while striking the perfect balance between ambience, style, and functionality with our Eclipse Smart-Heat™ Electric Portable Heater.





## ECLIPSE SMART-HEAT™ ELECTRIC

Dim the lights and turn up the heat with our Eclipse Smart-Heat™ Electric heater. Available in six unique mounting options, the new Bromic Eclipse Smart-Heat™ Electric series brings comfort, light and style to commercial and residential outdoor spaces.

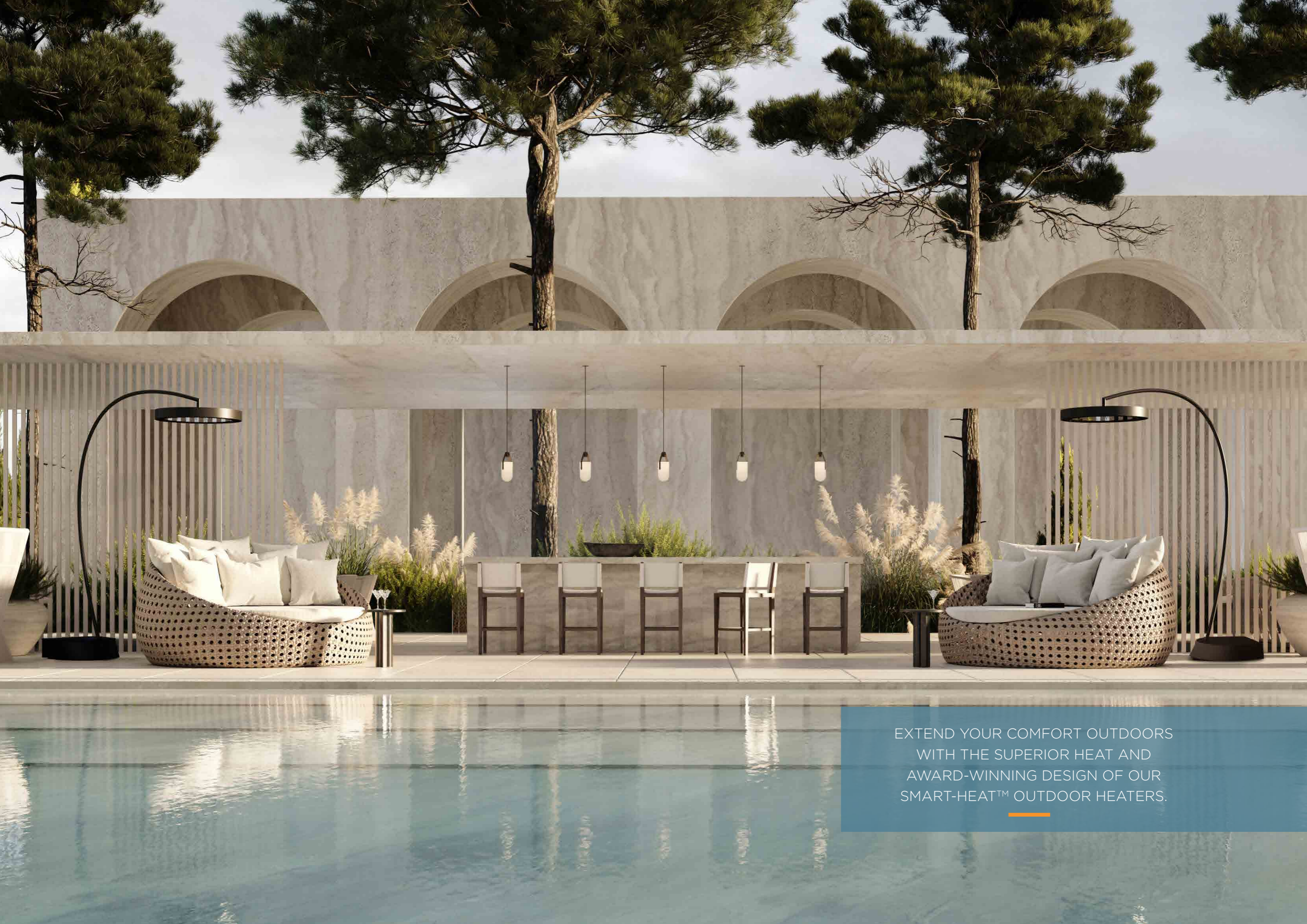

EXTEND YOUR COMFORT OUTDOORS  
WITH THE SUPERIOR HEAT AND  
AWARD-WINNING DESIGN OF OUR  
SMART-HEAT™ OUTDOOR HEATERS.



SEAMLESS INTEGRATION OF  
MODERN CLEAN LINES, MINIMALISTIC  
DESIGN AND QUALITY MATERIALS  
ACHIEVES INNOVATIVE STYLING AND  
TECHNICAL PERFORMANCE.

---

BRÖMIC

PLATINUM SMART-HEAT™ ELECTRIC  
WITH OPTIONAL RECESS KIT

PLATINUM  
SMART-HEAT™ ELECTRIC

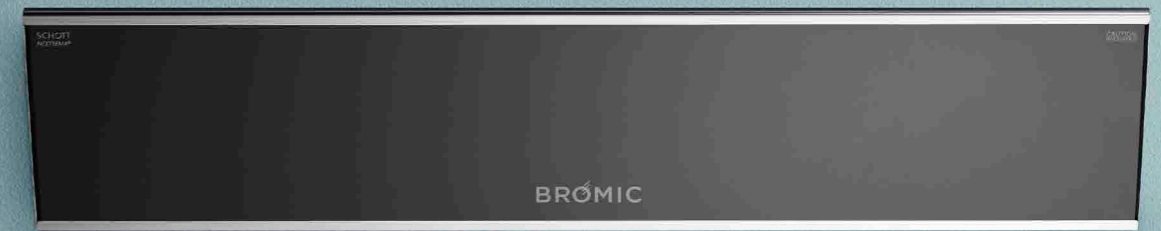
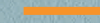

Available in black and white, our Platinum Smart-Heat™ Electric heater is specifically suited for low-clearance and design-focused spaces. This slim-line, stainless-steel unit spreads comfort evenly, all while minimising light emission and blending seamlessly into the background with our recess mounting solutions. The Platinum Electric range is also available in a marine-grade 316 stainless steel for extra longevity in coastal and marine environments.



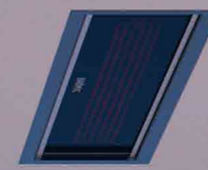
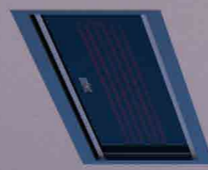

PLATINUM  
SMART-HEAT™ GAS



The Platinum Smart-Heat™ Gas heater series spreads heat and comfort evenly in all areas, with a soft and soothing red glow. Built with pure premium materials and designed with elegance, there is no compromise on performance, reliability and beauty.

TUNGSTEN  
SMART-HEAT™ ELECTRIC

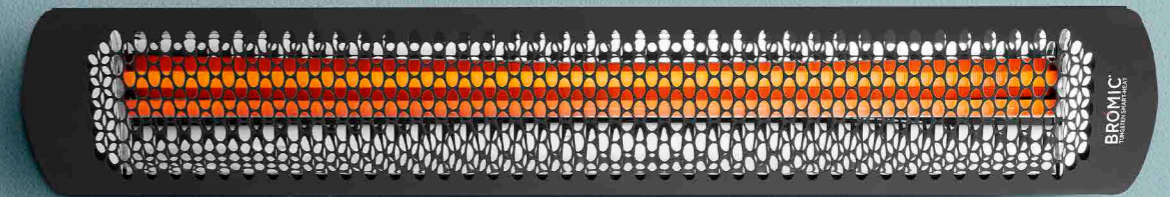

Our Tungsten Smart-Heat™ Electric series offers high performance radiant heating for outdoor and semi-enclosed spaces alike, with an industrial design style. It also boasts a high-temperature coating to suit all environments. With a stainless-steel construction, its durable element will emit a soft red glow to create a warm ambience in your space.

**BROMIC**  
TUNGSTEN SMART-HEAT

TUNGSTEN  
SMART-HEAT™ GAS

---

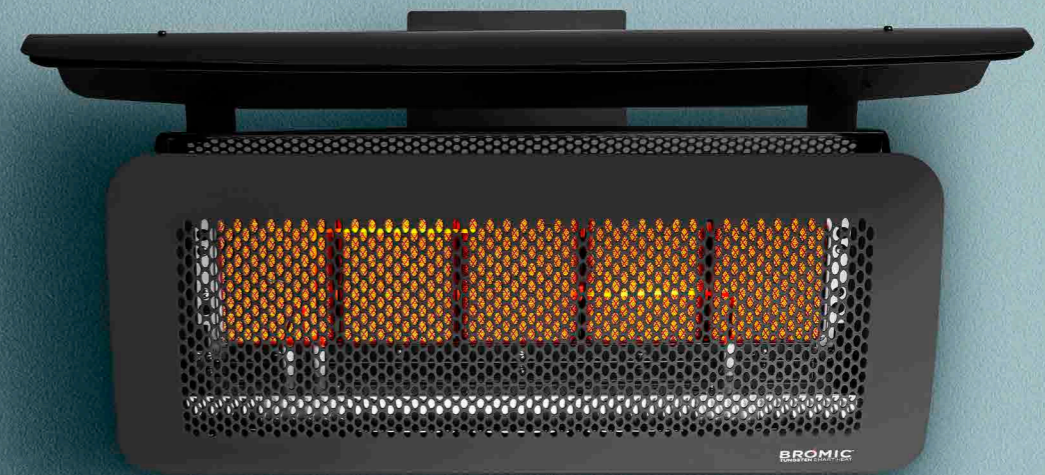

Our Tungsten Smart-Heat™ Gas heater has a durable, soft flowing curved facia and engineered body, which produces formidable heat to create a truly comfortable outdoor space. Its easy pivot arm allows for greater positioning and directional heat control. This heater also has a range of accessories available to provide versatility in mounting & controller options.



EXTEND YOUR COMFORT OUTDOORS  
WITH THE SUPERIOR HEAT AND  
AWARD-WINNING DESIGN OF OUR  
SMART-HEAT™ OUTDOOR HEATERS.



## TUNGSTEN SMART-HEAT™ PORTABLE

---

Its neutral black finish and award-winning design make it a piece of modern art. The Tungsten Smart-Heat™ Portable heater offers efficient directional heat and is a versatile heating solution for any outdoor setting. Its modular construction with built-in wheels allows for easy manoeuvrability throughout tighter spaces.

**SWITCH ON.  
GO WIRELESS.**

## SMART-HEAT™ WIRELESS CONTROLLERS

With the option to connect groups of heaters from a single point as well as dimming heating outputs, the Smart-Heat™ range of controllers provide a simple, yet powerful solution to controlling your environment.

Learn more about our wireless control options  
[bromic.com](http://bromic.com)



**ON | OFF 4-CHANNEL REMOTE\***  
(GAS & ELECTRIC)

The Bromic Smart-Heat™ Wireless On | Off Controller can switch power supply to two separate outputs, enabling independent 'On | Off' control without even having to move from your seat.



**DIMMER CONTROLLER\***  
(ELECTRIC ONLY)

The Bromic Smart-Heat™ Wireless Dimmer Controller allows you to adjust the heat from 1-100% for perfect comfort and complete flexibility.

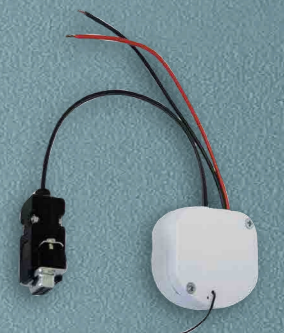

**BROMIC  
SMART-HEAT™ LINK**

The Bromic Smart-Heat™ Link is compatible with some of the leading Home Automation systems, allowing you to easily control your Bromic outdoor heaters from your home automation control panel.\*\*

\*\* Requires RS232 plugin

\*Please contact a Bromic heating specialist to discuss the ideal solution for your outdoor space. Our free design service includes wiring diagrams for set up options.

# ECLIPSE SMART-HEAT™ ELECTRIC PORTABLE

## MODEL

PRODUCT CODE	BH0820011-1
FUEL TYPE	ELECTRIC (3000W)
COLOUR	MATTE BLACK
MATERIAL (HEATER HEAD)	PREMIUM COATED 304 STAINLESS STEEL
MATERIAL (FREESTANDING FRAME)	PREMIUM, DOUBLE COATED STEEL
HEAT AREA	11M <sup>2</sup>
LED COLOUR	WARM WHITE - DIMMABLE
LED TEMPERATURE	3000K
LED LUMENS	216.6
RATED CURRENT & VOLTAGE	220-240 V - A.C. - 50-60 HZ
MINIMUM FLOOR CLEARANCE	2000MM

## MOUNTING OPTIONS

FREESTANDING	✓
--------------	---

## CONTROL OPTIONS

DIMMER CONTROL	INCLUDED
MASTER REMOTE ECLIPSE*	BH4623003-1 (OPTIONAL)

\*Control up to six zones of heaters with unlimited heaters per zone from a single remote. Dimmer control required.  
 Measurements displayed within this catalogue are minimum requirements for installation.  
 Bromic takes no responsibility for incorrect or non-compliant installations.  
 All measurements in this catalogue are displayed in mm.

## PRODUCT MEASUREMENTS

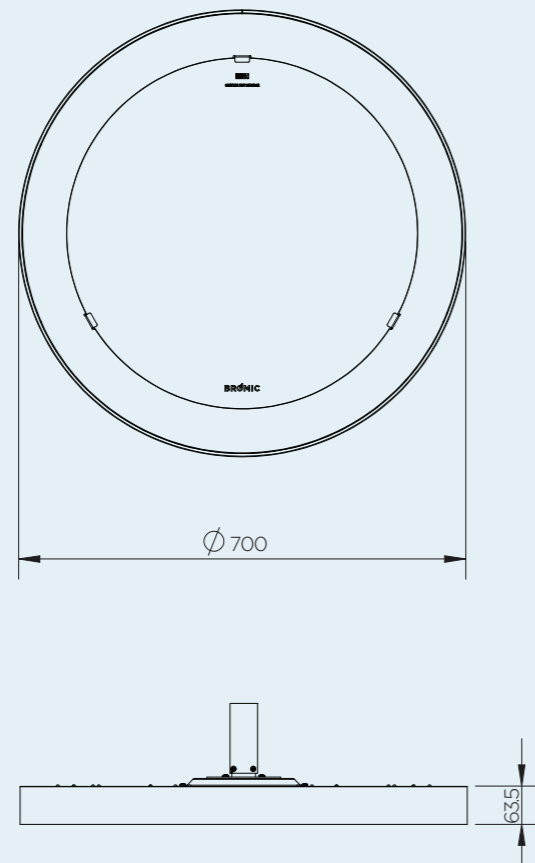

## FREESTANDING

FRONT VIEW

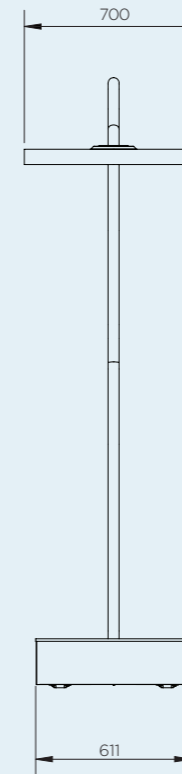

CEILING & WALL CLEARANCE

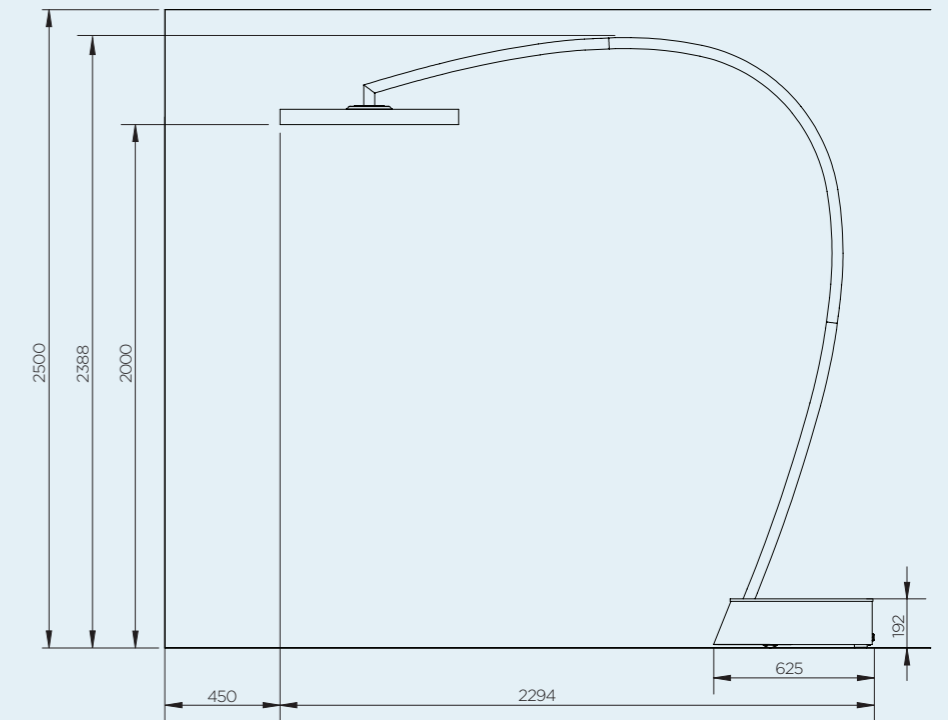

## HEAT AREA

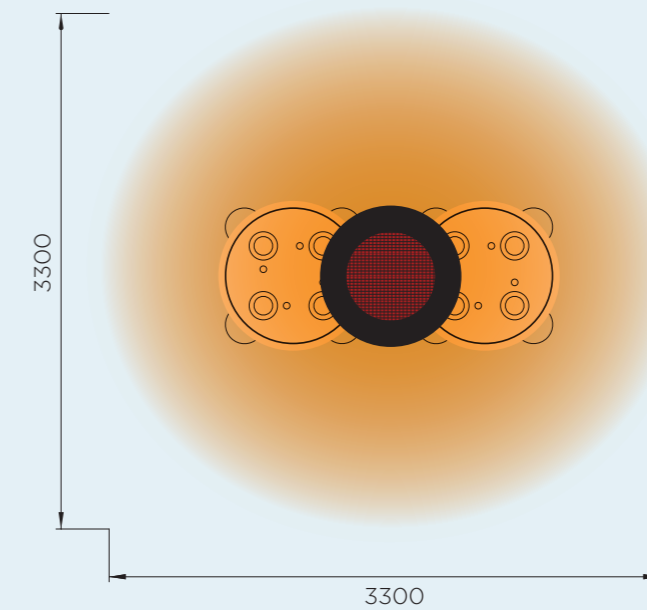

**3000W SERIES**  
 HEATING APPROXIMATELY 11M<sup>2</sup>  
 3000W HEATING POWER

\*HEAT AREA DEPENDENT ON AMBIENT TEMPERATURE AND WIND. OPTIMUM CONDITIONS EXPERIENCED AT APPROX 15.5°C AND IN A LOW WIND COVERED ENVIRONMENT.



# ECLIPSE SMART-HEAT™ ELECTRIC PENDANT

## MODEL

PRODUCT CODE	BH0920011-1
FUEL TYPE	ELECTRIC (3000W)
COLOUR	MATTE BLACK
MATERIAL (HEATER HEAD)	PREMIUM COATED 304 STAINLESS STEEL
MATERIAL (MOUNTING ARMS)	PREMIUM, DOUBLE COATED STEEL
HEAT AREA	11M <sup>2</sup>
LED COLOUR	WARM WHITE - DIMMABLE
LED TEMPERATURE	3000K
LED LUMENS	216.6
RATED CURRENT & VOLTAGE	220-240 V - A.C. - 50-60 HZ
MINIMUM FLOOR CLEARANCE	CEILING 2438MM   WALL 2438MM

## MOUNTING OPTIONS

WALL MOUNT	BH3230016 (OPTIONAL)
200MM STRAIGHT CEILING MOUNT POLE	BH3230011 (OPTIONAL)
600MM STRAIGHT CEILING MOUNT POLE	BH3230012 (OPTIONAL)
600MM TWIN STRAIGHT CEILING MOUNT POLE	INCLUDED
600MM CURVED CEILING MOUNT POLE	BH3230014 (OPTIONAL)
1200MM STRAIGHT CEILING MOUNT POLE	BH3230015 (OPTIONAL)

## CONTROL OPTIONS

DIMMER CONTROL	INCLUDED
MASTER REMOTE ECLIPSE*	BH4623003-1 (OPTIONAL)

\*Control up to six zones of heaters with unlimited heaters per zone from a single remote. Dimmer control required.

Measurements displayed within this catalogue are minimum requirements for installation. Bromic takes no responsibility for incorrect or non-compliant installations. All measurements in this catalogue are displayed in mm.

## PRODUCT MEASUREMENTS

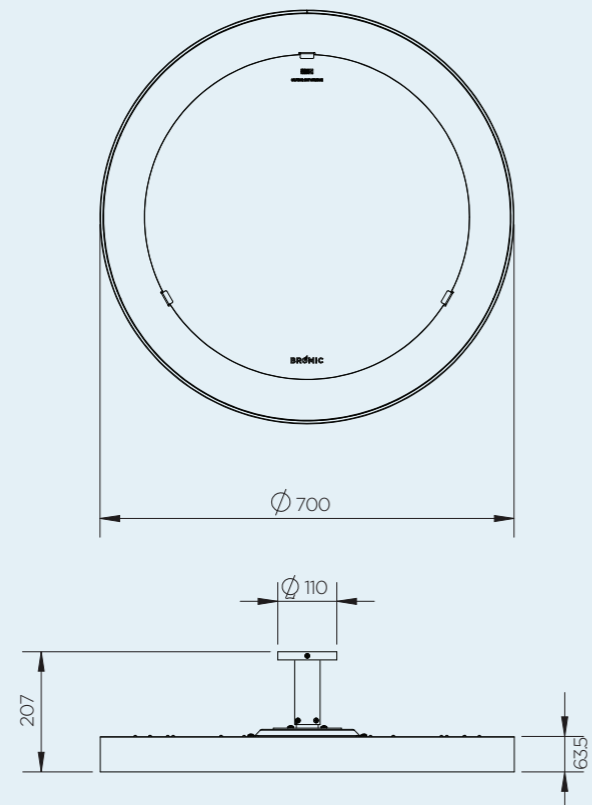

## CEILING MOUNTING OPTIONS

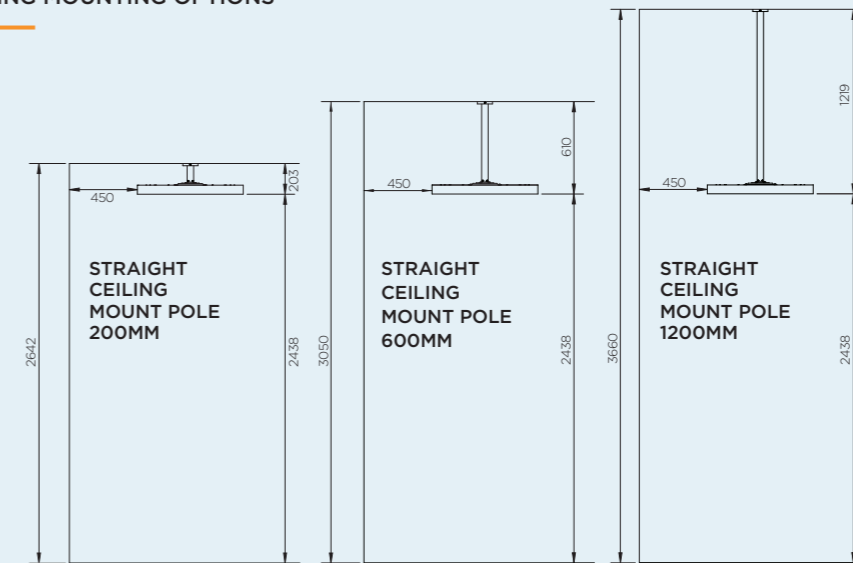

## WALL MOUNTING

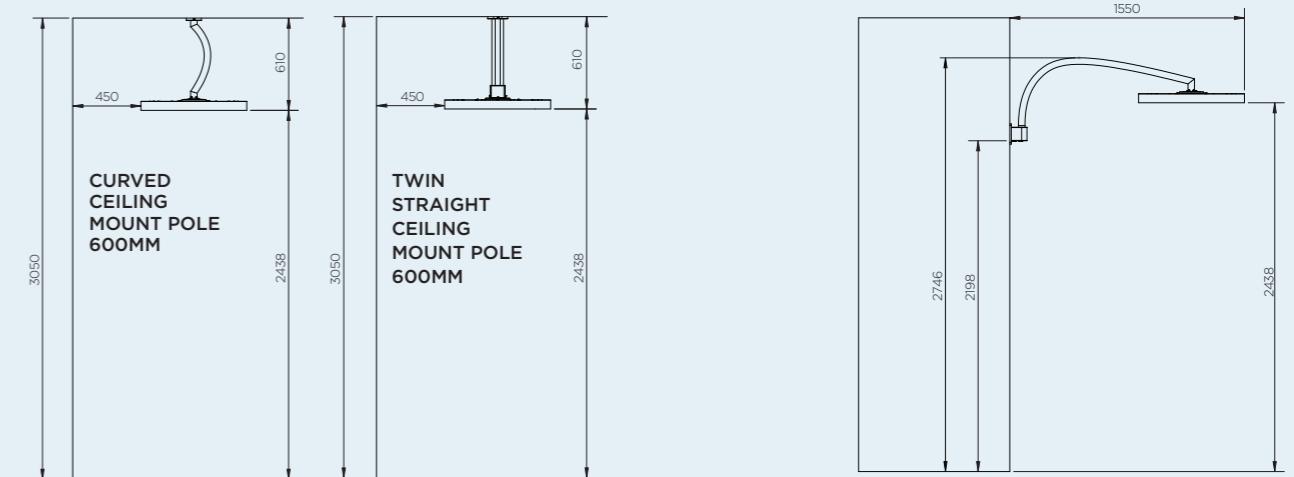

## HEAT AREA

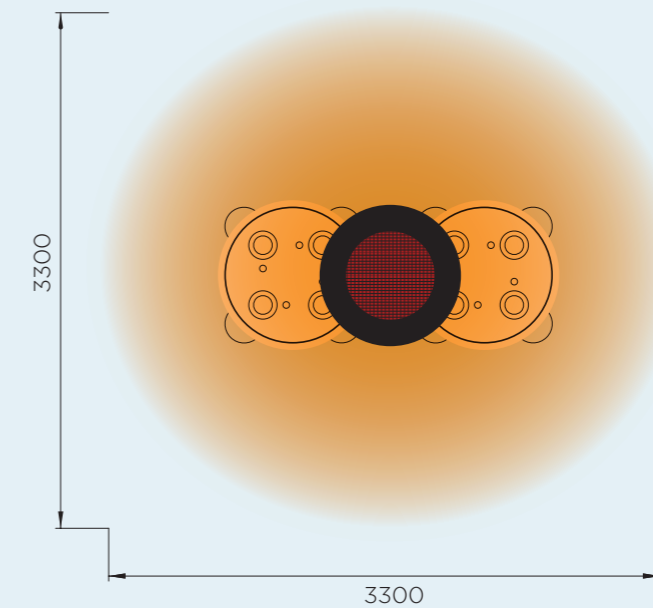

**3000W SERIES**  
HEATING APPROXIMATELY 11M<sup>2</sup>  
3000W HEATING POWER

\*HEAT AREA DEPENDENT ON AMBIENT TEMPERATURE AND WIND. OPTIMUM CONDITIONS EXPERIENCED AT APPROX 15.5°C AND IN A LOW WIND COVERED ENVIRONMENT.

# PLATINUM SMART-HEAT™ GAS

MODEL NUMBER	300 SERIES	500 SERIES
PRODUCT CODE	VARIOUS	VARIOUS
FUEL TYPE	LPG   NG	LPG   NG
COLOUR	BLACK   STAINLESS	BLACK   STAINLESS
HEAT AREA	12M <sup>2</sup>	20M <sup>2</sup>
RATED CURRENT	220 - 240 Va.c	220 - 240 Va.c
OUTPUT	25MJ	42MJ
MINIMUM FLOOR CLEARANCE	2500MM	2500MM

## MOUNTING OPTIONS

CEILING MOUNT	✓	✓
WALL MOUNT	✓	✓
RECESSED   FLUSH MOUNT	-	-
CEILING POLE MOUNT	✓	✓
FREESTANDING	-	-

## CONTROL OPTIONS

ON   OFF	✓	✓
ON   OFF PRODUCT CODE	BH3130019-1	BH3130019-1
DIMMER	-	-
MASTER REMOTE	-	-

Measurements displayed within this catalogue are minimum requirements for installation. Bromic takes no responsibility for incorrect or non-compliant installations. All measurements in this catalogue are displayed in mm.

## CEILING & WALL MOUNT CLEARANCE

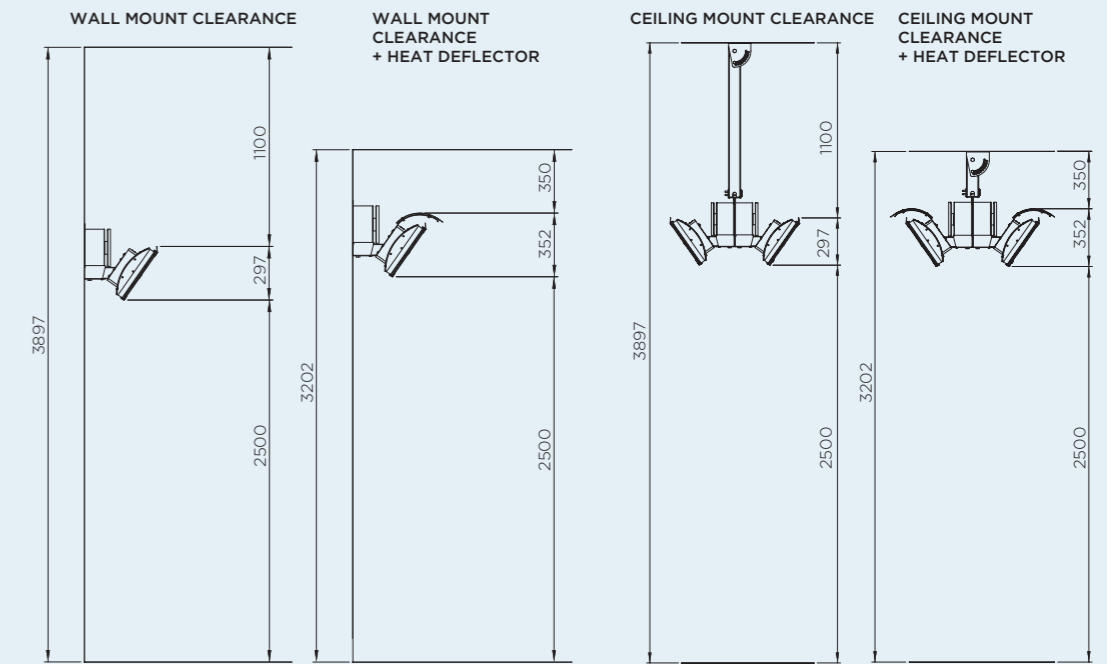

## WALL BRACKET

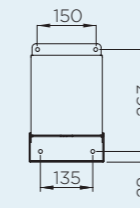

## PRODUCT MEASUREMENTS

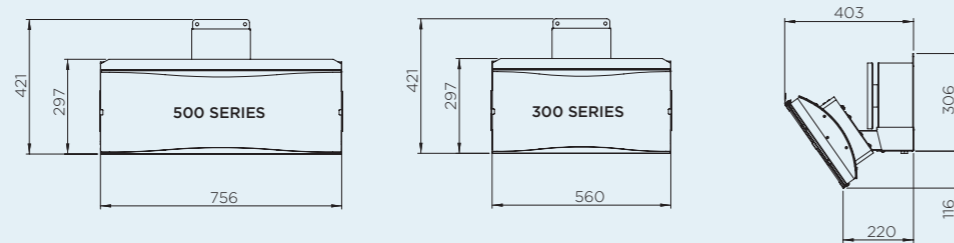

## PRODUCT MEASUREMENTS WITH HEAT DEFLECTOR

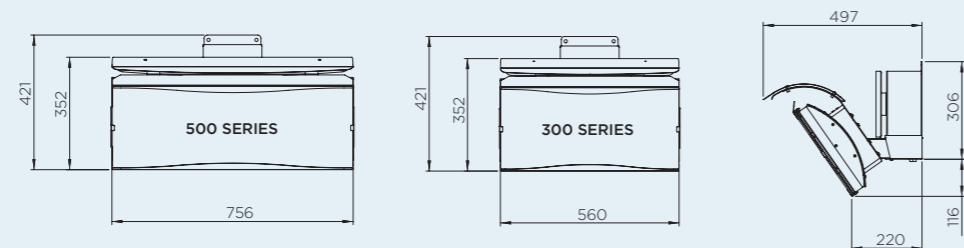

## HEAT AREA

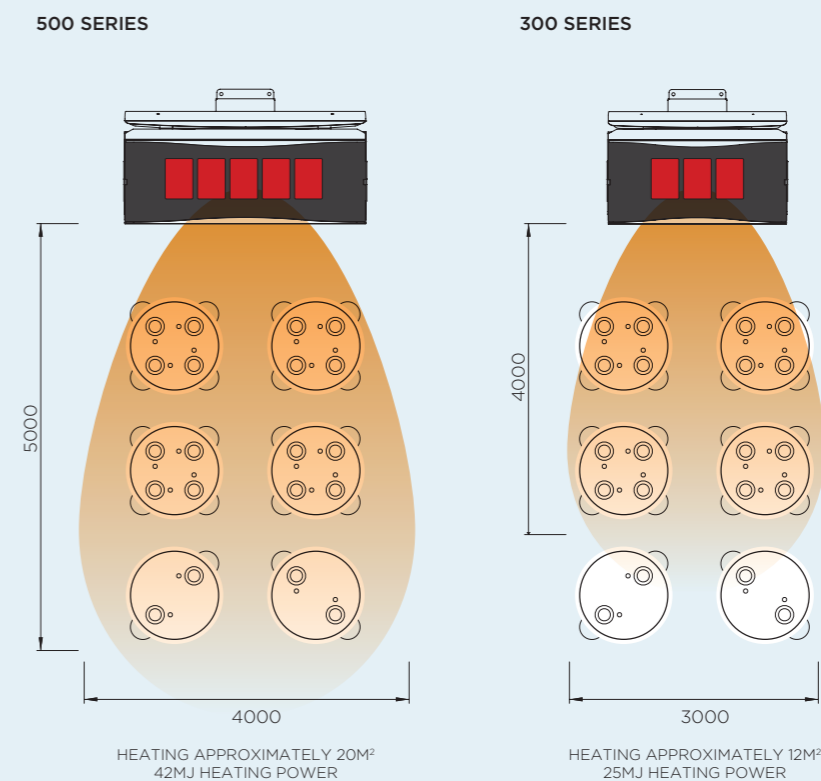

\*HEAT AREA DEPENDENT ON AMBIENT TEMPERATURE AND WIND. OPTIMUM CONDITIONS EXPERIENCED AT APPROX 15.5°C AND IN A LOW WIND COVERED ENVIRONMENT.

HEATING APPROXIMATELY 20M<sup>2</sup>  
42MJ HEATING POWER

HEATING APPROXIMATELY 12M<sup>2</sup>  
25MJ HEATING POWER

# PLATINUM SMART-HEAT™ ELECTRIC

MODEL NUMBER	2300W SERIES	3400W SERIES
PRODUCT CODES PLATINUM ELECTRIC	BH0320004   BH0320009	BH0320006   BH0320010
PRODUCT CODES PLATINUM ELECTRIC MARINE	BH0320011   BH0320013	BH0320012   BH0320014
FUEL TYPE	ELECTRIC	ELECTRIC
COLOUR	BLACK   WHITE	BLACK   WHITE
HEAT AREA	6M <sup>2</sup>	10M <sup>2</sup>
RATED CURRENT	220 - 240V/9.6A	220 - 240V/14.2A
MINIMUM FLOOR CLEARANCE	WALL 1800MM   CEILING 2400MM	WALL 1800MM   CEILING 2400MM
<b>MOUNTING OPTIONS</b>		
CEILING MOUNT	✓	✓
CEILING RECESS KIT PRODUCT CODES	BH3130017	BH3130027
WALL MOUNT	✓	✓
RECESSED   FLUSH MOUNT	✓	✓
CEILING POLE MOUNT	✓	✓
CEILING POLE (600MM) PRODUCT CODE	BH3130023	BH3130023
CEILING POLE (1200MM) PRODUCT CODE	BH3130024	BH3130024
FREESTANDING	-	-
<b>CONTROL OPTIONS</b>		
ON   OFF	✓	✓
ON   OFF PRODUCT CODE	BH3130019-1	BH3130019-1
DIMMER	✓	✓
DIMMER PRODUCT CODE	BH3130020-1	BH3130020-1
MASTER REMOTE *	✓	✓
MASTER REMOTE PRODUCT CODE	BH3130021	BH3130021

\* Control up to six zones of heaters with unlimited heaters per zone from a single remote control. Dimmer control required. Remote control operates within 30m of heaters.

Measurements displayed within this catalogue are minimum requirements for installation. Bromic takes no responsibility for incorrect or non-compliant installations. All measurements in this catalogue are displayed in mm.

## PRODUCT MEASUREMENTS

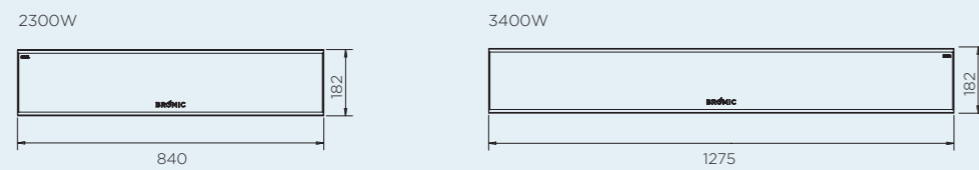

## CEILING RECESS KIT

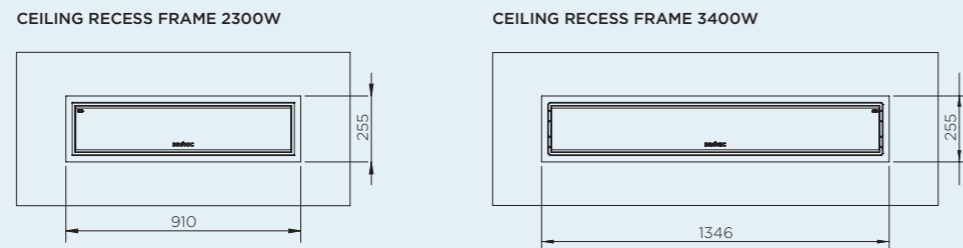

## CEILING CAVITY GUIDE

MINIMUM CAVITY SIZE FOR BOTH 2300W & 3400W MODELS

### OPTION 1 - STANDARD CAVITY SPACE

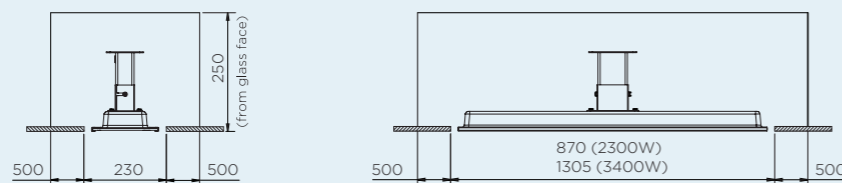

### OPTION 2 - NARROW CAVITY SPACE

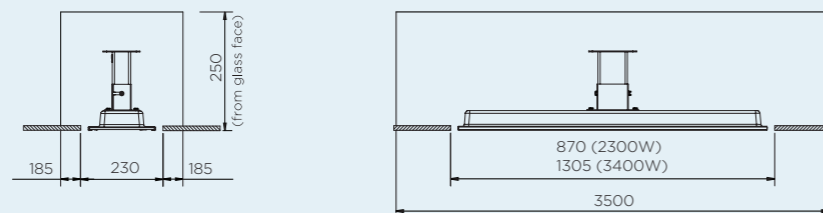

## CEILING & WALL MOUNT CLEARANCE

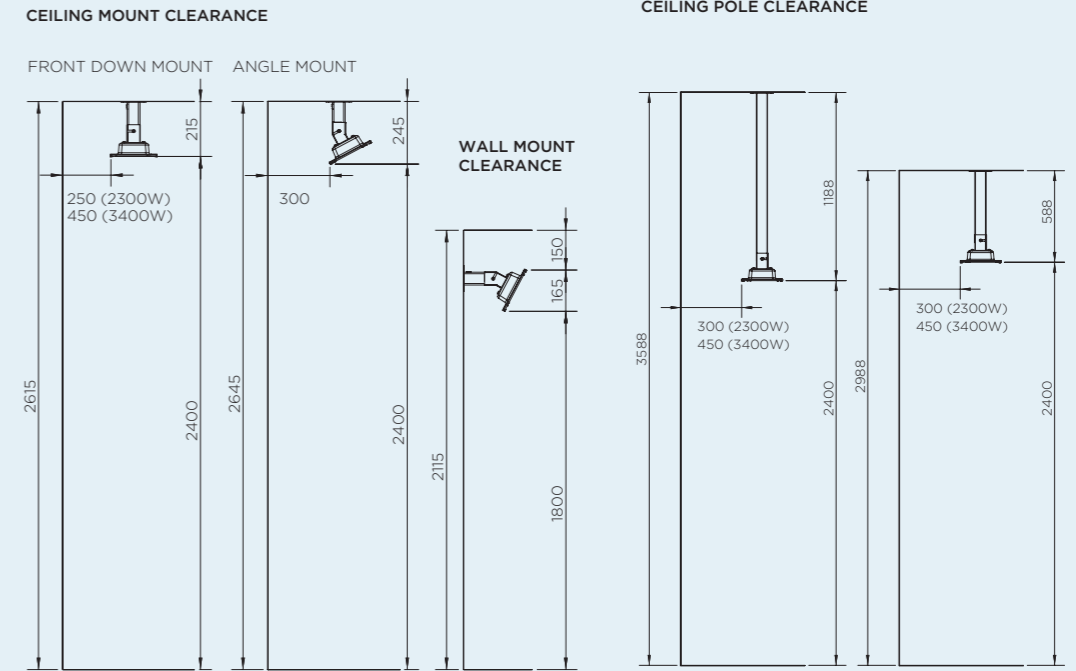

## WALL BRACKET (INCLUDED)

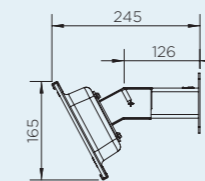

## CEILING BRACKET (INCLUDED)

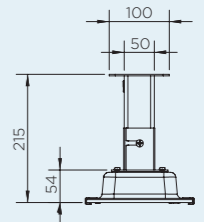

## HEAT AREA

**2300W SERIES**  
HEATING APPROXIMATELY 6M<sup>2</sup>  
2300W HEATING POWER

**3400W SERIES**  
HEATING APPROXIMATELY 10M<sup>2</sup>  
3400W HEATING POWER

\*HEAT AREA DEPENDENT ON AMBIENT TEMPERATURE AND WIND. OPTIMUM CONDITIONS EXPERIENCED AT APPROX 15.5°C AND IN A LOW WIND COVERED ENVIRONMENT.

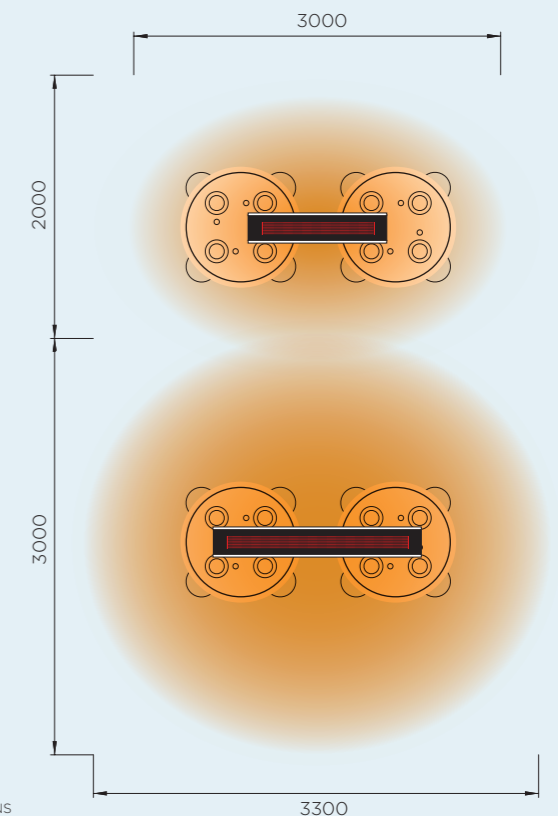

# TUNGSTEN SMART-HEAT™ GAS

MODEL NUMBER	300 SERIES	500 SERIES
PRODUCT CODE	VARIOUS	VARIOUS
FUEL TYPE	LPG   NG	LPG   NG
COLOUR	BLACK	BLACK
HEAT AREA	12M <sup>2</sup>	20M <sup>2</sup>
ELECTRICAL CONNECTION	220 - 240 Va.c.	220 - 240 Va.c.
OUTPUT	25MJ	42MJ
MINIMUM FLOOR CLEARANCE	2500MM	2500MM

## MOUNTING OPTIONS

CEILING MOUNT	✓	✓
WALL MOUNT	✓	✓
RECESSED   FLUSH MOUNT	-	-
CEILING POLE MOUNT	✓	✓
FREESTANDING	-	-

## CONTROL OPTIONS

ON   OFF	✓	✓
ON   OFF PRODUCT CODE	BH3130019-1	BH3130019-1
DIMMER	-	-
MASTER REMOTE	-	-

Measurements displayed within this catalogue are minimum requirements for installation. Bromic takes no responsibility for incorrect or non-compliant installations. All measurement in this catalogue are displayed in mm.

## PRODUCT MEASUREMENTS

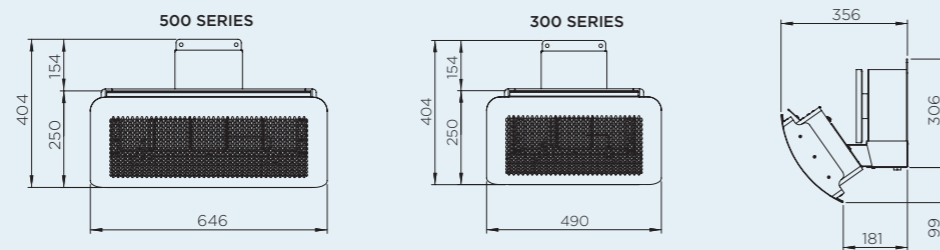

## PRODUCT MEASUREMENTS WITH HEAT DEFLECTOR

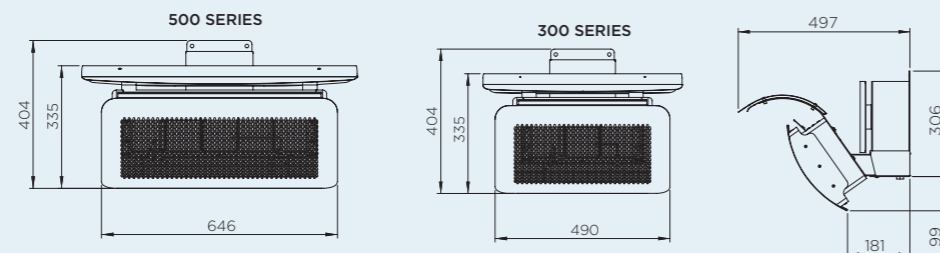

## CEILING & WALL MOUNT CLEARANCE

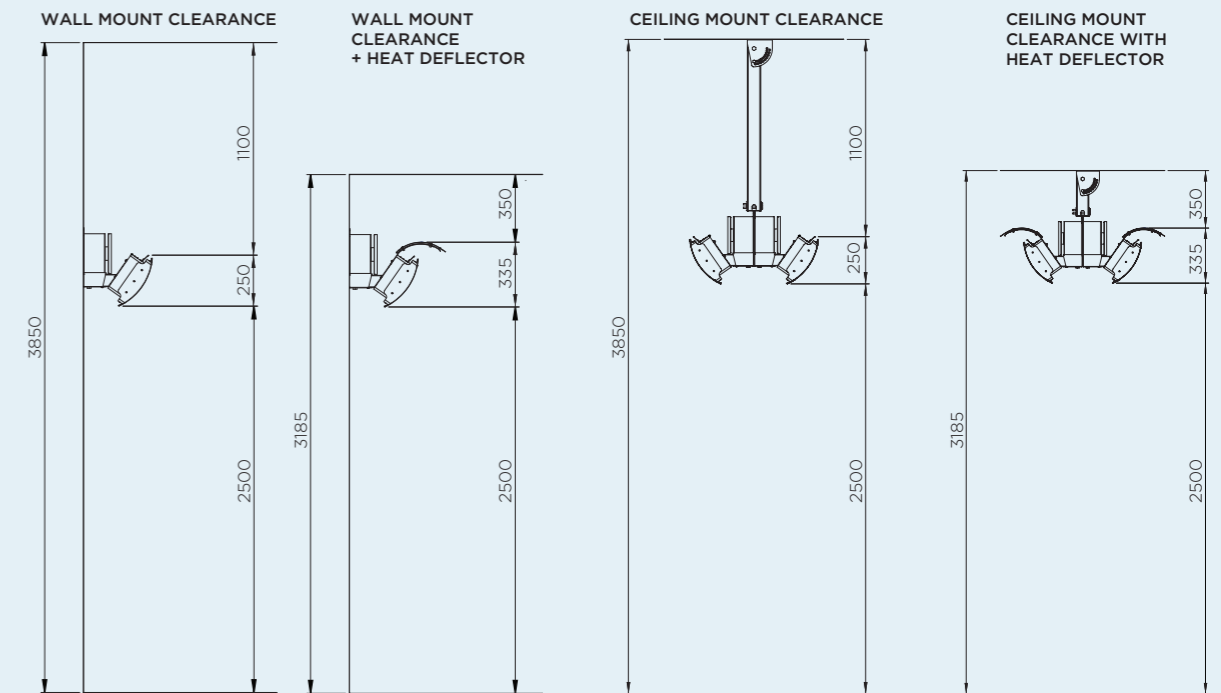

## WALL BRACKET

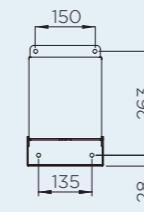

## HEAT AREA

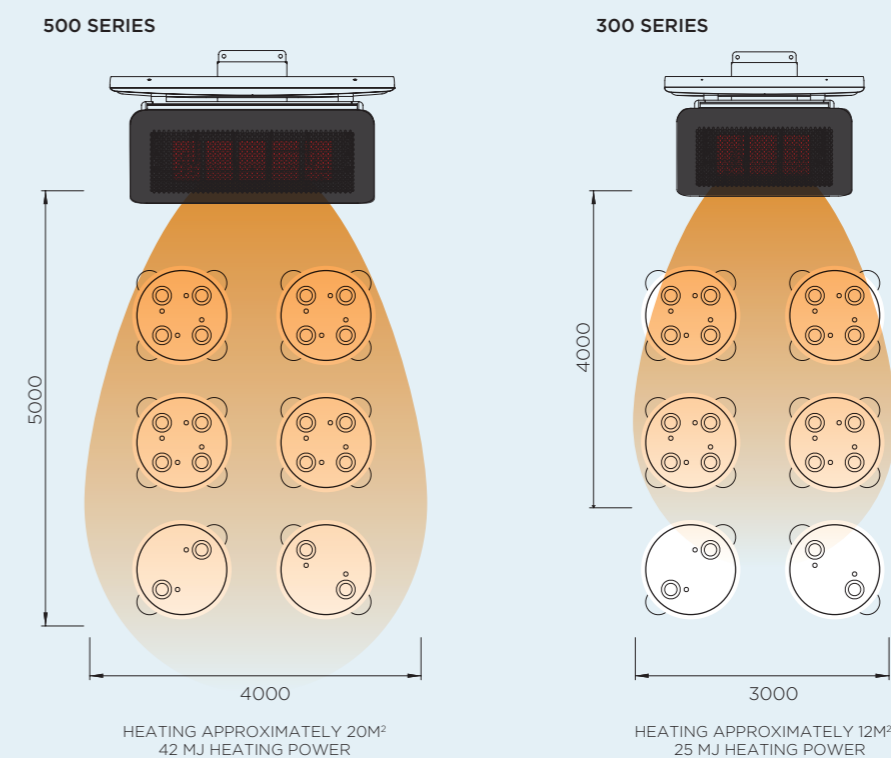

\*HEAT AREA DEPENDENT ON AMBIENT TEMPERATURE AND WIND. OPTIMUM CONDITIONS EXPERIENCED AT APPROX 15.5°C AND IN A LOW WIND COVERED ENVIRONMENT.

# TUNGSTEN SMART-HEAT™ ELECTRIC

MODEL NUMBER	2000 SERIES	3000 SERIES	4000 SERIES	6000 SERIES
PRODUCT CODE	BH0420022-1 BH0420026-1	BH0420023-1 BH0420027-1	BH0420024-1 BH0420028-1	BH0420025-1 BH0420029-1
FUEL TYPE	ELECTRIC	ELECTRIC	ELECTRIC	ELECTRIC
COLOUR	BLACK   WHITE	BLACK   WHITE	BLACK   WHITE	BLACK   WHITE
HEAT AREA	6M <sup>2</sup>	9M <sup>2</sup>	11M <sup>2</sup>	13M <sup>2</sup>
RATED CURRENT **	220 - 240V/8.3A	220 - 240V/12.5A	220 - 240V/16.6A	220 - 240V/25A
MINIMUM FLOOR CLEARANCE	WALL 1800MM   CEILING 2400MM		WALL 1800MM   CEILING 2400MM	

## MOUNTING OPTIONS

CEILING MOUNT	✓	✓	✓	✓
CEILING RECESS KIT PRODUCT CODES	BH8180010	BH8180011	BH8180010	BH8180011
WALL MOUNT	✓	✓	✓	✓
RECESSED   FLUSH MOUNT	✓	✓	✓	✓
CEILING POLE MOUNT	✓	✓	✓	✓
TUBE SUSPENSION KIT PRODUCT CODE	BH8180012			
FREESTANDING	-	-	-	-

## CONTROL OPTIONS

ON   OFF	✓	✓	✓	✓
ON   OFF PRODUCT CODE	BH3130019-1			
DIMMER	✓	✓	✓	✓
DIMMER PRODUCT CODE	BH3130020-1			
MASTER REMOTE *	✓	✓	✓	✓
MASTER REMOTE PRODUCT CODE	BH3130021			

Measurements displayed within this catalogue are minimum requirements for installation. Bromic takes no responsibility for incorrect or non-compliant installations. All measurements in this catalogue are displayed in mm.  
 \* Control up to six zones of heaters with unlimited heaters per zone from a single remote control. Dimmer control required. Control operates within 30m of heaters.  
 \*\* Black models only.

## PRODUCT MEASUREMENTS

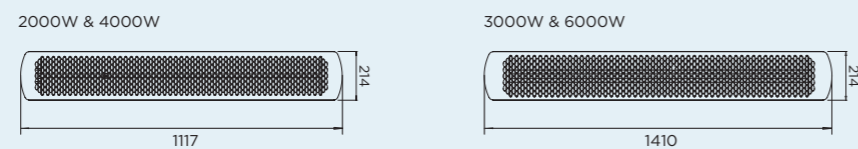

## CEILING RECESS

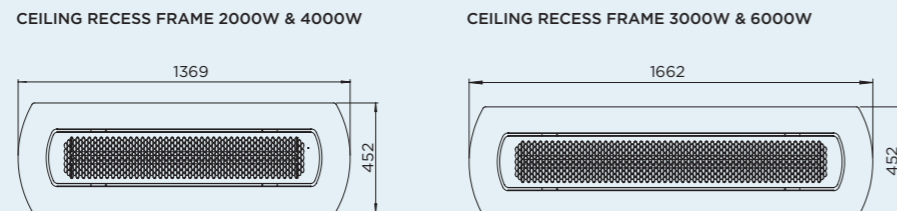

## CEILING RECESS

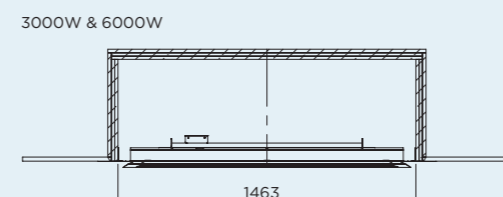
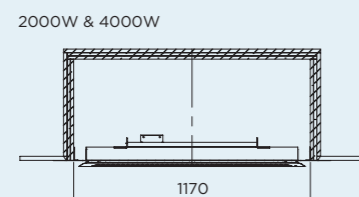
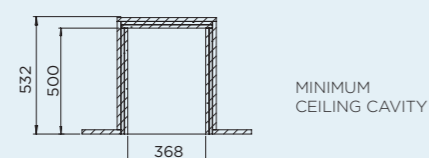

## CEILING & WALL MOUNT CLEARANCE

### CEILING MOUNT CLEARANCE

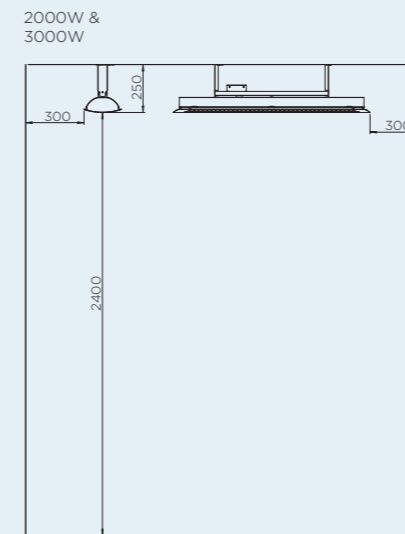

### CEILING MOUNT CLEARANCE

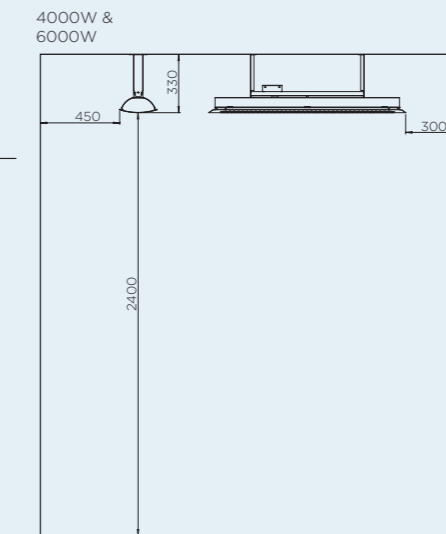

### CEILING POLE CLEARANCE

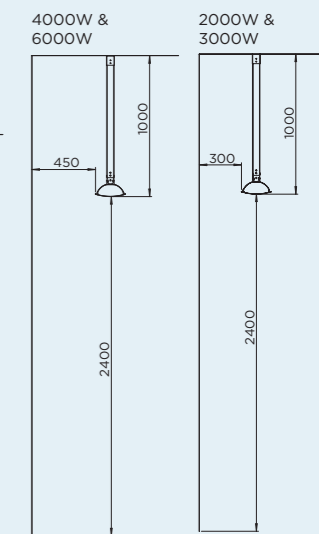

## WALL BRACKET (INCLUDED)

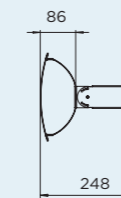

2000W & 3000W

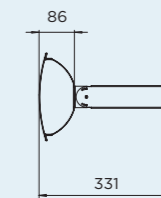

4000W & 6000W

## HEAT AREA

### 2000W SERIES

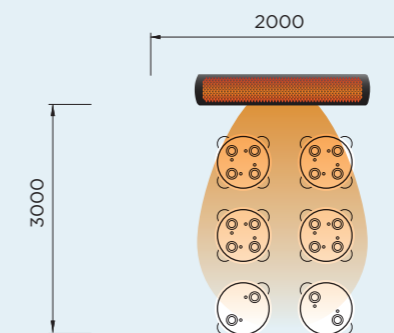

### 3000W SERIES

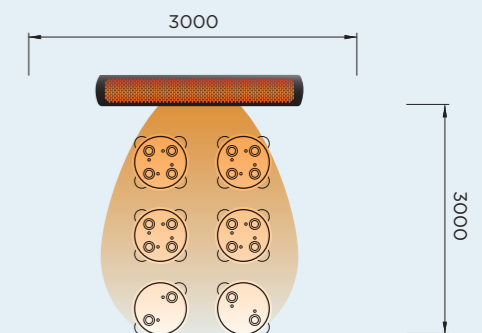

### 4000W SERIES

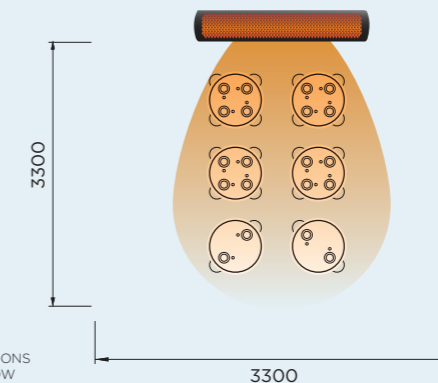

### 6000W SERIES

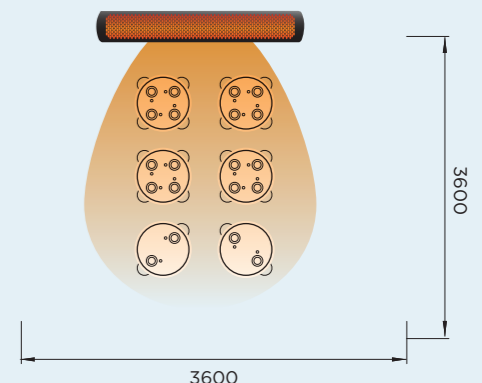

\*HEAT AREA DEPENDENT ON AMBIENT TEMPERATURE AND WIND. OPTIMUM CONDITIONS EXPERIENCED AT APPROX 15.5°C AND IN A LOW WIND COVERED ENVIRONMENT.

# TUNGSTEN SMART-HEAT™ PORTABLE

## MODEL NUMBER

PRODUCT CODE	VARIOUS
FUEL TYPE	LPG
COLOR	BLACK
HEAT AREA	20M <sup>2</sup>
RATED CURRENT	-
OUTPUT	40MJ
MINIMUM CEILING CLEARANCE	1000MM

## MOUNTING OPTIONS

CEILING MOUNT	-
WALL MOUNT	-
RECESSED   FLUSH MOUNT	-
CEILING POLE MOUNT	-
FREESTANDING	✓

## CONTROL OPTIONS

ON   OFF	-
DIMMER	-
MASTER REMOTE	-

## ADDITIONAL OPTIONS

NATURAL GAS CONVERSION KIT PRODUCT CODE	BH8280050
HEATER COVER PRODUCT CODE	BH3030010

Measurements displayed within this catalogue are minimum requirements for installation.  
Bromic takes no responsibility for incorrect or non-compliant installations.  
All measurements in this catalogue are displayed in mm.

## PRODUCT MEASUREMENTS

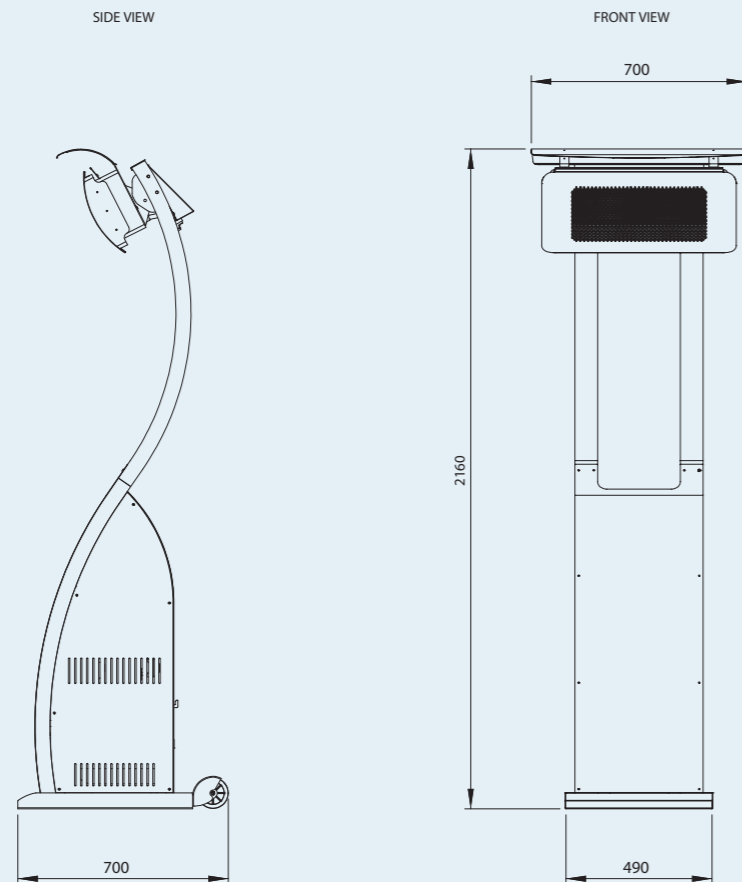

## CEILING & WALL CLEARANCE

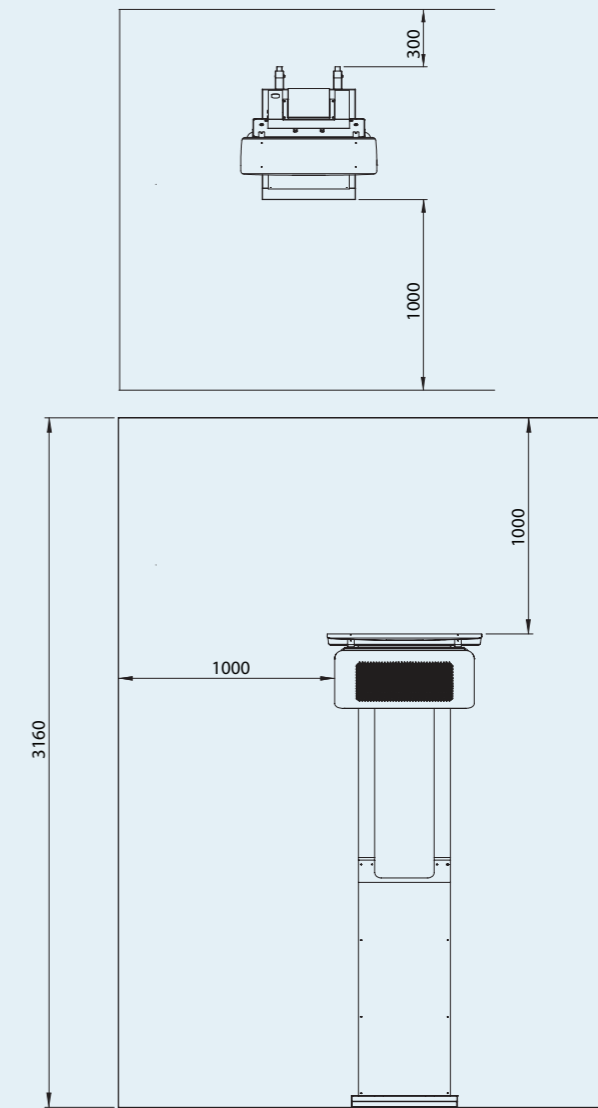

## HEAT AREA

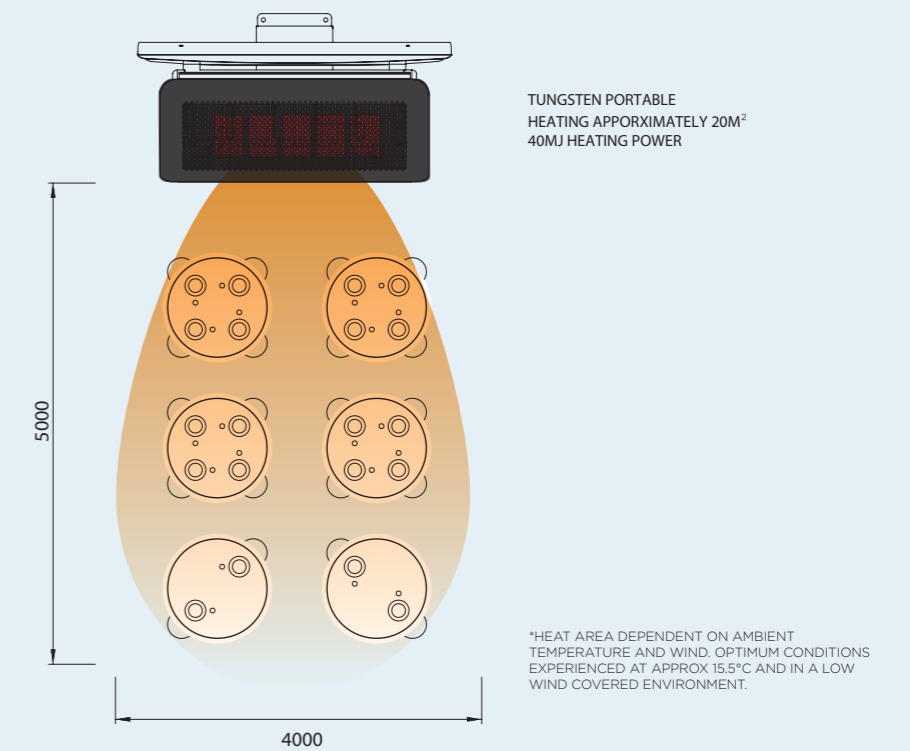

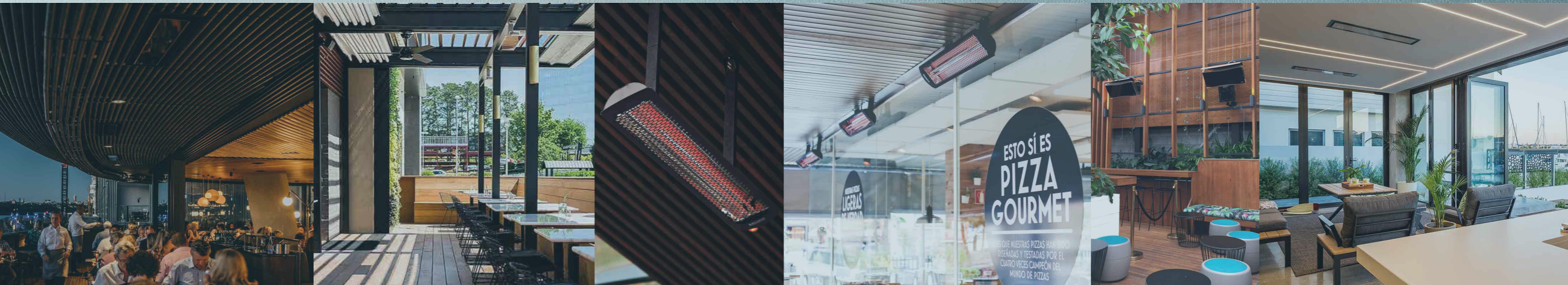

## DESIGN SERVICE

---

As part of our complimentary service, Bromic Heating Specialists will custom design and tailor a solution to best heat your outdoor living and entertainment spaces.

Learn more about our design service  
[bromic.com](https://www.bromic.com)



## ABOUT BROMIC GROUP

---

Bromic's reputation for industry and innovation reaches back to 1978. Initially a supplier of gas components, Bromic has since grown to become an international leader that designs, manufactures and distributes a diverse range of quality, engineered products on a global scale.



**BROMIC.COM**

ASIA PACIFIC | NORTH AMERICA | EUROPE

UK\_03/2022